

# CR9 USER MANUAL

LIGHT SOURCE FOR FORENSIC CRIME SCENE INVESTIGATION

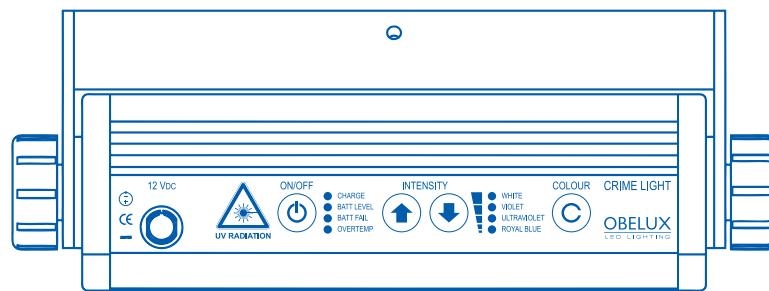

CONTENTS	3
SAFETY INSTRUCTIONS	4
DELIVERY CONTENTS	5
FEATURES	6
OPERATION	8
COMPONENTS	12
TROUBLESHOOT	15
TECHNICAL SPECIFICATIONS	16

# CR9 USER MANUAL

LIGHT SOURCE FOR FORENSIC CRIME SCENE INVESTIGATION



**Thank you for choosing Obelux CR9 LED crime light for a crime scene investigation tool. After a little time of use you will find many advantages of the CR9 crime light compared to other lights in the market.**

Patented technology helps you to create uniform, more effective oval and spot light beam to target surface without hotspots. Rectangular body enables easy set of light while examine or taking picture from the target. Also rectangular shape increases body area which works for better heat dissipation and thus able to increase light intensity to achieve better efficiency, longer lifetime and lighter construction. LED's are controlled with current and PWM combination which allows us to get even 40% better efficiency from the LEDs, power consumption savings and longer battery operation time.

Please read this manual through carefully to know how to use the CR9 crime light properly. In any problems consult the chapter "Troubleshoot" or contact to Obelux helpdesk or sales office.

**Have a nice working with Obelux CR9 crime light.**

## Contents

1 Safety Instructions	4
2 Delivery Contents	5
2.1 Supplied items	5
2.2 Damage in shipment	5
3. Features	6
3.1 Overview	6
3.2 Light unit	6
4 Operation	8
4.1 Turning power on and off	8
4.2 Changing light colour	8
4.3 Changing light intensity	8
4.4 Checking battery charge level	9
4.5 Charging battery	9
4.6 Changing battery	10
4.7 Checking temperature	11
5 Components	12
5.1 Filter goggles	13
5.2 Camera filter system	14
6 Troubleshoot	15
7 Technical specifications	16
7.1 Light unit	16
7.2 AC adapter	16

### 1 Safety Instructions

In this section you will find general safety instructions of Obelux CR9 crime light to avoid any personal, material or environmental damages. Please read the instructions carefully before using the device.

#### General considerations:

- Keep your device away from radiators, heat sources, dust, humidity, smoke or other harmful substances
- Use only battery and AC adapter delivered with the device or approved by the manufacture
- Disconnect AC adapter from wall outlet and device during an electrical storm
- Do not place the device in a closed-in wall unit, a bed, sofa or rug
- Do not cover the device when it's been used
- Do not spill food or liquids on the device
- If you have an error situation with the device or battery, do not try to fix it by yourself. Contact to your reseller.



#### Environmental considerations:

- Device or battery should not be disposed with normal household waste. It should be disposed at an appropriate facility to enable recovery and recycling.
- For information how to recycle this product responsibly in your country, please visit: [www.recycling-guide.org](http://www.recycling-guide.org).

**WARNING:** To prevent the spread of fire, keep candles or other open flames away from this product at all times.



**WARNING:** HIGH ENERGY! Device contains Lithium-Polymer battery which has high energy stored inside. Any device misuse might damage the battery and cause dangerous behavior. If any error situation occurs, do not try to fix it by yourself.



**WARNING:** UV LIGHT! Do not look directly at light!



- Unprotected and long expose of any kind of UV radiation, including UV-A radiation, can lead to skin damages, cataract or cancer. Even a small exposure could be dangerous if the intensity of UV radiation is high. That is why it is very important to protect your eyes with UV goggles, hands and arms with clothing of non-fluorescent material.
- Artificial UV-light is considered to be totally different than UV-light emitted by sun light. That is not true. Artificial UV-light should be considered as normal sun light and thus recommended protection and safety instructions should be observed. Artificial UV-lights are used in many different industries and applications.
- Some people are naturally especial sensitive for UV radiation and they should avoid to exposure to any kind of UV-lights. If any indication (itching, infection etc.) appears, exposal of the UV radiation should be ended immediately. People who use pharmaceutical products that increase photosensitivity should avoid the exposure of UV-lights.
- Obelux CR9 crime lights use artificial UV-lights with LED technology. At least the following colours and wave-lengths are emitted: violet 410 nm, deep blue 450 nm, UV-LED 365 nm and UV-LED 385 nm. It is absolutely necessary to protect your eyes from UV radiation with specified goggles. Obelux CR9 crime lights include the best UV-goggles in the market. They absorb 99.9 % of all under the wavelength of 385 nm lights.

## 2 Delivery Contents

### 2.1 Supplied items

Check the list of supplied items. Verify that you have received all items listed on the packing list. If anything is missing, please contact Obelux sales office.

### 2.2 Damage in shipment

Inspect the device thoroughly and immediately upon receipt for evidence of external or internal damage that may have occurred during shipment. Immediately notify the carrier making the delivery of any damage, since the carrier is usually liable for damage in shipment. Preserve packing materials, waybills and other shipping documentations in order to claim any damages. After notifying the carrier, contact Obelux to receive assistance in the damage claims and provide replacement equipment if necessary.

### 3 Features

#### 3.1 Overview

Obelux CR9 crime light is a multicolour and portable light source for forensic crime scene investigation. CR9's each section colour intensity is the most extensive and plane compared to other light sources on the market. Wide light opening guarantees smooth luminance distribution without hotspots. Product is slim and functional considering all its many features. Integrated lithium battery technology allows long and wireless operating time for investigation. AC operation extends operation time while battery is been charged. The adjustable handle with tripod socket helps controlling the light beam, for example footprint examination.

##### Key features:

- Adjustable built-in intensity control
- Stabilized light output
- Shock and vibration resistant
- Very low power consumption
- Range of long life LED light sources
- Range of wavelengths including UV and white
- Spot and oval light beam, without hotspots
- Rechargeable batteries
- Battery and AC operated
- Battery discharge protection
- Over temperature protection
- Tripod socket 1/4" -20 UNC in handle
- Splash waterproof, IP 54
- Portable crime scene kits

#### 3.2 Light unit

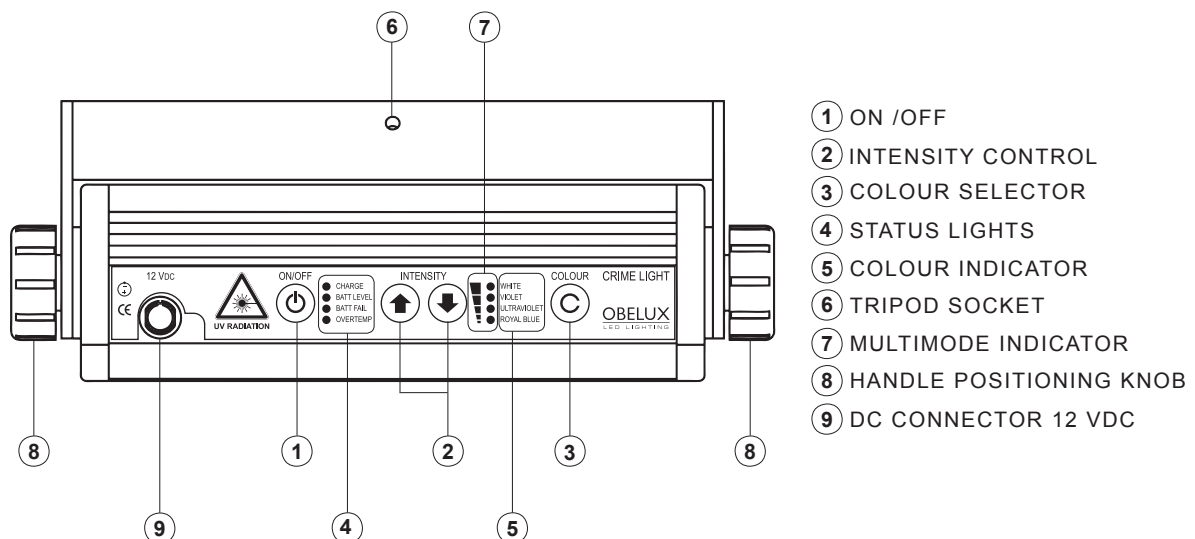

## 1. ON / OFF

- Device turn on / off after 0.5 s delay with default situation, remember colour and intensity.
- Special two button function when pressing ON / OFF and other button within 0.5 s. See other buttons.

## 2. INTENSITY CONTROL

Intensity up

- Increase intensity with 8 steps
- Battery level: Press ON / OFF and intensity up within 0.5 s to see battery level from multimode indicator.

Intensity down

- Decrease intensity with 8 steps

## 3. COLOUR SELECTOR

- Select light colour
- Temperature: Press ON / OFF and colour selector within 0.5 s to see temperature from multimode indicator

## 4. COLOUR INDICATOR

- Shows which light colour is active

## 5. STATUS LIGHTS

### Charge: Yellow

Flashing every three second

- Battery full and device is connected to an electrical outlet

ON:

- Charging battery

Flashing with OVERTEMP light:

- Battery too cold or too hot, unable to charge

OFF and device is connected to an electrical outlet:

- Input voltage too low, unable to charge

### Batt Level: Green

Flashing:

- Battery level under 10%

ON:

- See battery level from multimode indicator

### Bat Fail: Red

Flashing:

- Battery life time ending, change battery soon

ON:

- Battery fail, change battery immediately, device works only with an electrical outlet

### Over Temp: Red

Flashing slowly:

- Device too warm and lights intensity is limited

Flashing fast:

- Device too cold (-20°C) and lights turned off

ON:

- Device too hot (+60°C) and leds turned off

## 6. TRIPOD SOCKET

- ¼"-20 UNC socket for tripod

## 7. MULTIMODE INDICATOR

Intensity level:

- Shows intensity level with 8 steps, activated for 4 s.

Battery level:

- Shows battery level with 8 steps, activated for 4 s.

Temperature:

- Shows device temperature, 0 – 80 C with 8 steps, activated for 4 s.

Charging:

- Shows charging procedure, pre-charge, charge, post-balance

## 8. HANDLE POSITIONING KNOB

Two handle positioning knobs for adjusting handle

## 9. DC CONNECTOR

12 VDC connector for AC adapter

## 4 Operation

Obelux CR9 crime light is very easy to use. All operations are done with four buttons and device status is indicated with multicolour status lights. In this section you will find all functions and how to use them.

### 4.1 Turning power on and off

CR9 crime light is turned on by pressing ON/OFF button. Device will turn on after 0.5 seconds to its state contained when previously turned off (light colour and intensity). When turned on, multimode indicator is activated and shows light intensity. After 4 seconds, multimode indicator is deactivated and colour indicator set to light colour in use. CR9 crime light is turned off by pressing ON/OFF button. Device will save its state (light colour and intensity) to memory and turn off after 0.5 seconds.

### 4.2 Changing light colour

Some CR9 models (eg. CR9-UWV-A1) includes multiple light colours which can be changed by pressing COLOUR button. Each time pressing COLOUR button, light colour will change and colour indicator shows which colour is in use. In one colour light model (eg. CR9-B-A1) pressing colour button will change colour intensity to minimum.

### 4.3 Changing light intensity

CR9 crime light intensity can be change by pressing INTENSITY up and down arrows. There are eight steps for intensity level. After each change, multimode indicator is activated for 4 seconds and it shows current intensity level.



**NOTE!** Using high intensity level increases current consumption and device temperature. High current consumption will significantly lower battery operating time. It is totally normal that device gets warm when using high intensity level. If temperature rises too high device will automatically limit lights intensity level to avoid device to get too hot. If temperature still rises, lights will turn off.



### 4.4 Checking battery charge level

Battery charge level can be checked at any time operating the device. To check the battery level, press ON/OFF button and within 0.5 second INTENSITY arrow up button. BATT LEVEL status light will turn on and multimode indicator is activated for 4 seconds to show battery level. If BATT LEVEL status light is flashing, battery charge level is under 10% and it should be charged.

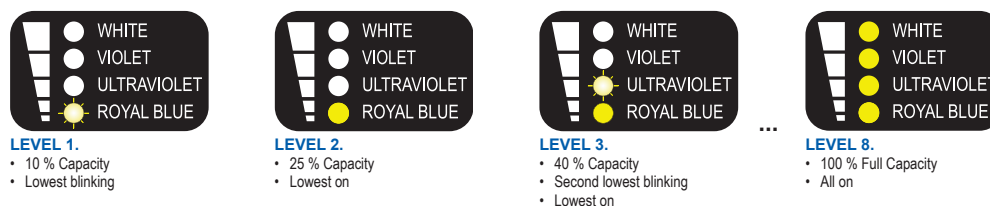

### 4.5 Charging battery

CR9 crime light battery consists of two different lithium cells which both are been charged separately. In that way, cells can be charged always to its maximum capacity and thus increase the device operation time and battery lifetime.

To charge CR9 crime light battery, connect AC adapter plug to DC CONNECTOR and other end to wall outlet. Within few seconds yellow CHARGE status light will turn on. If device is on, multimode indicator shows previously selected light colour. If device is off multimode indicator is activated.

**Multimode indicator shows different charging steps as follows:**

1. Pre-charge: low charge current, two lights go around indicator, app. 40 – 300 seconds
2. Charge: charge current, one light go fast from down to up, app. 3 hours
3. Post-balance: low current, one light go back and forth, at least 40 seconds, typical 10 minutes

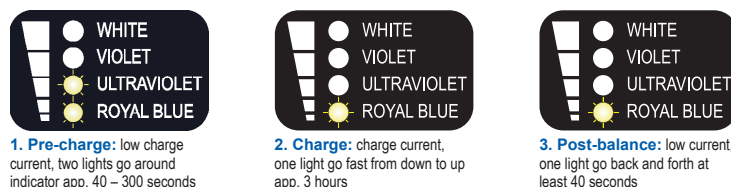

Charge battery as long as battery charge level is full and CHARGE status light will flash every three seconds and multimode indicator is deactivated. It is recommended to keep the device in charger always not been used.

**NOTE!** Battery life time depends how device has been used (temperature, intensity level etc.) or has been charged (charge count, temperature etc.). Post-balance step is very critical for battery operation time. Device contains two battery cells and operation time equals lower cell capacity. In post-balance, both cells are charged to maximum and operation time is increased approximately 10% comparing to normal charge method. Charging is disabled if device temperature is below 0 Celsius or above +40 Celsius or battery charge level is over 85% from its maximum capacity. The maximum charge count is about 500 cycles from empty to full. When count reaches to maximum, first BATT FAIL status light starts to flash. It means battery life time is ending. When BATT FAIL status light is on, battery life time is exceeded and needs to be replaced immediately.

### 4.6 Changing battery

When changing new battery to CR9 crime light follow the instruction below:

1. Make sure battery is empty. If not use device until battery is completely discharged. Remove handle by opening handle positioning knobs
2. Remove end panel marked with "battery replacement" by opening screws (picture 1.)
3. Remove battery from inside the device (picture 2.)
4. Add new battery by pushing battery inside the device while pressing INTENSITY up and down arrows simultaneously. Pressing buttons will clear the battery charge information from the device and clear the BATT FAIL status light (picture 3.)
5. BATT LEVEL and BATT FAIL status lights will turn on for 4 seconds to show new battery is connected and information is cleared
6. Close end panel with the screws opened
7. Connect handle using positioning knobs
8. Dispose old battery observing your country specific recycling laws

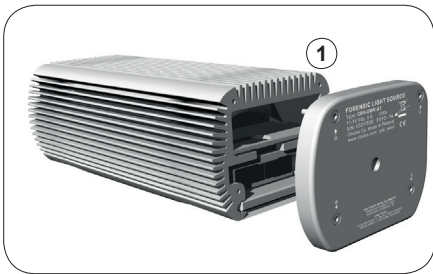

**1** Picture 1: Remove end panel marked with "battery replacement" by opening screws.

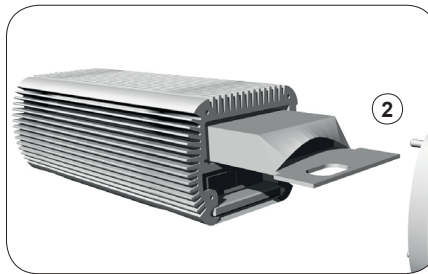

**2** Picture 2: Remove battery from inside the device.

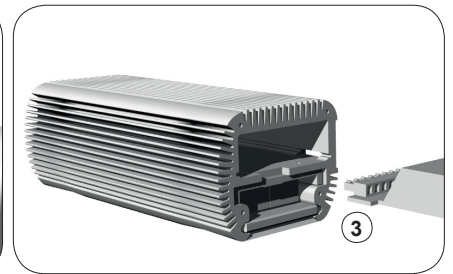

**3** Picture 3: Add new battery by pushing battery inside the device while pressing INTENSITY up and down arrows simultaneously.

### 4.7 Checking temperature

CR9 crime light temperature can be checked when device is turned on by pressing ON/OFF button and within 0.5 second COLOUR button. Red OVERTEMP status light will turn on and multimode indicator is activated for 4 seconds to show device temperature.

If temperature rises too high (+55 Celcius), OVERTEMP status light will flash and device will automatically decrease lights intensity level to avoid device to get too hot. Intensity change is seen with a little flash. CR9 crime light can still be used but it is recommended to decrease manually light intensity. If temperature still rises (+60 Celsius), OVERTEMP status light turn on and lights will turn off.

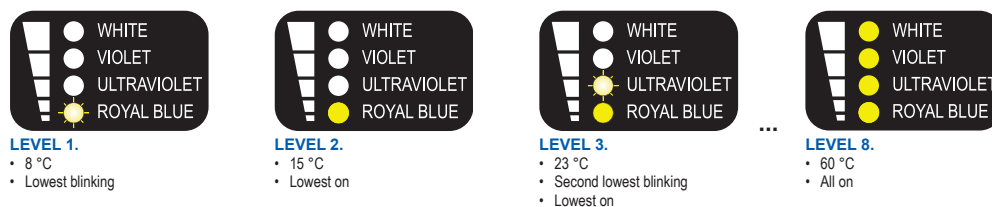

# CR9

## LIGHT SOURCE FOR FORENSIC CRIME SCENE INVESTIGATION

### 5 Components

CR9 crime light supports many additional external components which use help crime scene investigation.

**The supported components are:**

- AC adapter 230VAC
- Car adapter 12VDC
- Carrying case
- Filter goggles (clear, red, yellow, orange)
- Camera filter system (red, yellow, orange)
- Lens cloth



Picture 1: Carrying case



Picture 2: Camera filter system



Picture 3: Filter goggles



Picture 4: Car adapter 12 DVC, Lens cloth, AC adapter 230 VAC

### 5.1 Filter goggles

Filter goggles is used to filter specific light wavelengths so that the target (foot or finger print etc.) is seen better. For different targets there are different colour filter goggles: clear, yellow, orange and red. Each goggles have they own filter transmittance curve. Obelux filter goggles can be used with normal glasses.

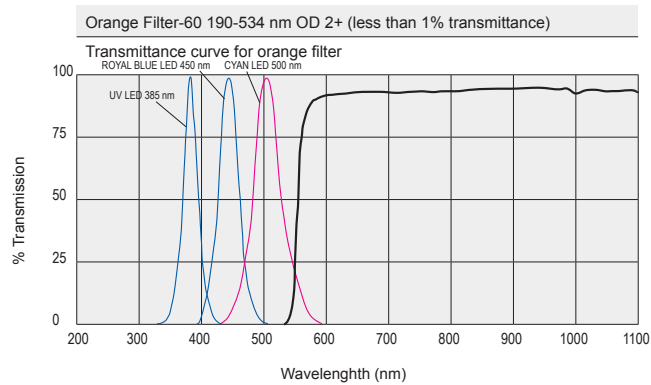
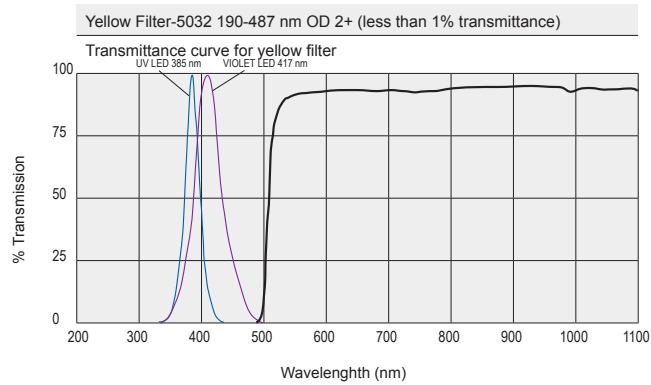
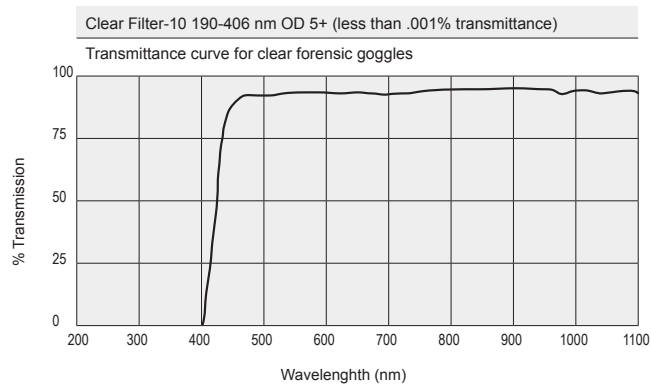

Picture 1: Light wavelengths and camera and goggles filter transmittance curve

### 5.2 Camera filter system

Camera filter system consists of three main items: camera adapter ring, filter holder and filter sheets. Adapter ring size depends of camera lens diameter and should be ordered according to your camera lens. Available adapter ring diameters vary from 48 to 82 mm.

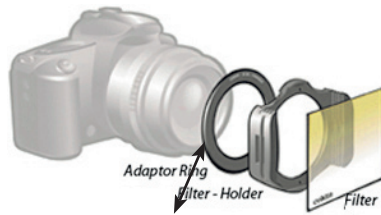

**Picture 1:** When ordering, check lens outer diameter.



**NOTE!** To get the best out of the CR9 crime light, it is recommended to use filter goggles and camera filter sheets same colour and made of same material. Even a little difference in material affects very much to visual effect how the crime scene target is seen through goggles or camera. Obelux CR9 filter goggles and camera sheets are made with same material and they are tested to work together with the CR9 light wavelengths so the result for investigation is optimal.

## 6 Troubleshoot

Problem	Possible reasons	Solutions
CHARGE status light is off even I have charger connected	<ul style="list-style-type: none"> <li>Charger is not connected to wall outlet</li> <li>Charger output voltage is too low or too high</li> <li>Battery charge level is over 85% it's maximum capacity</li> </ul>	<ul style="list-style-type: none"> <li>Connect charger to wall outlet</li> <li>Check charger and it's output voltage. See voltage range from technical specifications.</li> <li>Use device with battery to lower battery charge level</li> </ul>
CHARGE and OVERTEMP status lights flashing simultaneously	<ul style="list-style-type: none"> <li>Device is too warm, over +40 Celsius</li> </ul>	<ul style="list-style-type: none"> <li>Cool down device, charging starts automatically</li> </ul>
CHARGE and OVERTEMP status lights flashing separately	<ul style="list-style-type: none"> <li>Device is too cold, below 0 Celsius</li> </ul>	<ul style="list-style-type: none"> <li>Warm up device, charging starts automatically</li> </ul>
OVERTEMP status light flashing	<ul style="list-style-type: none"> <li>Device too warm, +55 Celcius</li> </ul>	<ul style="list-style-type: none"> <li>Turn off device or decrease light intensity</li> </ul>
OVERTEMP status light on	<ul style="list-style-type: none"> <li>Device too hot, +60 Celsius</li> </ul>	<ul style="list-style-type: none"> <li>Turn off device or decrease light intensity</li> </ul>
BATT FAIL status light flashing	<ul style="list-style-type: none"> <li>Battery life time ending</li> </ul>	<ul style="list-style-type: none"> <li>Contact to your reseller to purchase new battery</li> </ul>
BATT FAIL status light on	<ul style="list-style-type: none"> <li>Battery life time exceeded</li> </ul>	<ul style="list-style-type: none"> <li>Change new battery immediately</li> </ul>
BATT FAIL status light is on even battery has been changed to new	<ul style="list-style-type: none"> <li>Battery charge information is not cleared from device when changing battery</li> </ul>	<ul style="list-style-type: none"> <li>Clear battery charge information, see "Changing battery" chapter</li> </ul>
Target is not visible in camera picture even it is seen with goggles	<ul style="list-style-type: none"> <li>Goggles and camera filter sheet are for different wavelengths</li> <li>Goggles and camera filter sheet are made by different manufacture</li> <li>Goggles and camera filter sheet are from different materials</li> </ul>	<ul style="list-style-type: none"> <li>Change camera filter sheet to same manufacture and material as goggles</li> </ul>
Pressing COLOUR button sets light intensity to minimum	<ul style="list-style-type: none"> <li>CR9 crime light model in use supports only one colour</li> </ul>	<ul style="list-style-type: none"> <li>Purchase model with wanted colour supported</li> </ul>

If you didn't find solution to your problem, please contact Obelux helpdesk at [info@obelux.com](mailto:info@obelux.com).

## 7 Technical specifications

### 7.1 Light unit

Size (length x width x height)	220 x 88 x 50 mm
Weight	1.9 kg (with battery)
Battery	39 Wh, lithium polymer
Operation time	60 min, 100% light intensity 120 min, 85% light intensity
Device operation temperature	-20°C...+60°C
Ambient operation temperature	-20°C...+40°C
Operation temperature	-20°C...+50°C
Charging temperature	0°C...+40°C
Storage temperature	-20°C...+60°C
External supply voltage	11.2 Vdc...18 Vdc
DC connector type	ODU G81L0C-P02MPH0-0000
Wavelengths	UV 385 ± 5 nm Violet 417 ± 5 nm White 5500 ± 500 K Royal blue 450 ± 10 nm
Housing	Black anodized aluminum body, AISI 316 acid proof steel screws

### 7.2 AC adapter

Input voltage	90...264 Vac
Frequency	50...60 Hz
Inrush current	60 A max @ 240 Vac
Output voltage	12 Vdc
Output current	5.5 A max
Conducted EMI	CISPR / FCC Class B
Isolation	Input to output = 4242 Vdc
Leakage current	3.5 mA max
Holdup time	8 ms typ @ 115 Vac
Short circuit protection	Continuous
Over voltage protection	Yes
Operation temperature	0...+40°C
Storage temperature	-20°C...+85°C
Size (length x width x height)	132 x 58 x 30.5 mm
Weight	345 g
AC inlet	IEC 320 / C14
DC cable length	3 m extra long





# OBELUX

LED LIGHTING

Headquarters, R&D,  
Manufacturing, Domestic and  
International sales

Obelux Oy  
Kutomotie 6B  
FI-00380 Helsinki  
Finland

Tel +358 9 6871 6800  
Fax +358 9 621 5518  
E-mail [info@obelux.com](mailto:info@obelux.com)  
[www.obelux.com](http://www.obelux.com)

